



BUTYL INNER TUBES

The World Best Quality and Service
for Customer's Satisfaction.

TIRE INNER TUBE

- | INNER TUBES |
- | FLAPS |
- | CURING ENVELOPES |
- | CURING BLADDERS |



ON AUTOMOTIVE HISTORY

1971 ~

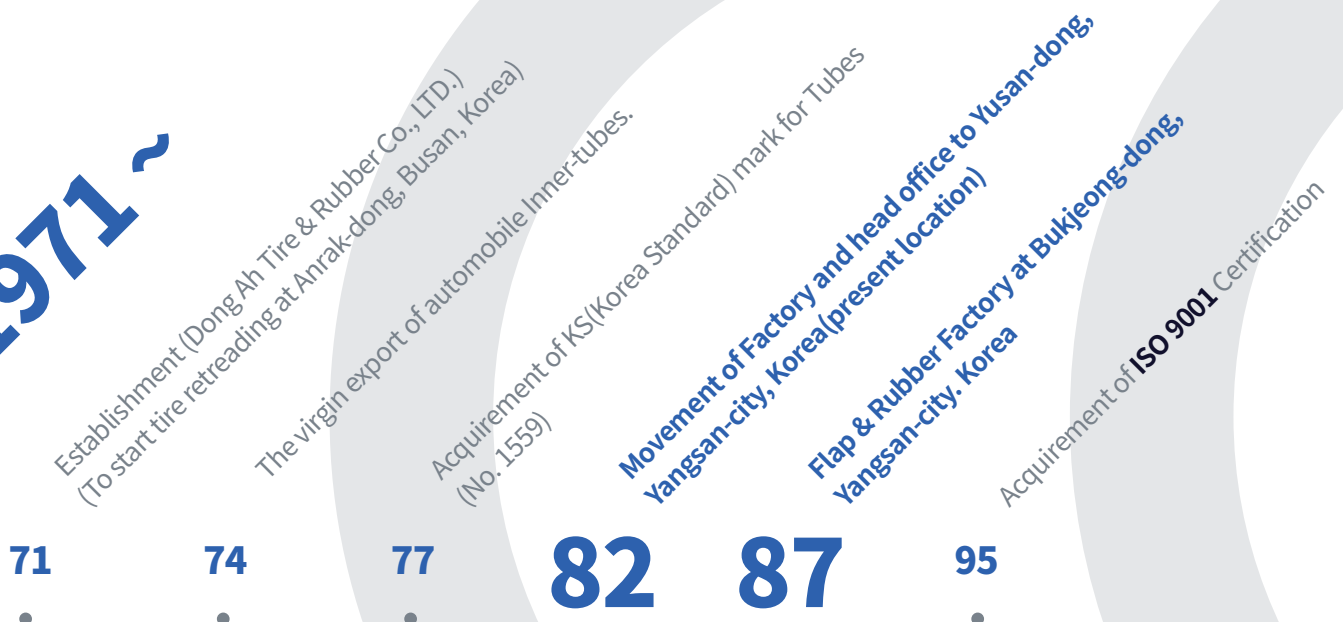

Head office & Tube Plant

Production Items : Inner Tubes
 Lot Area : 540,000 sq. ft
 Location : Yusan-dong, Yangsan City(Korea)



Head office & Tube Plant

Production Items : Flap, Carbon Master Batch, Bladder
 Lot Area : 461,000 sq. ft
 Location : Bukjeoung-dong, Yangsan City(Korea)

2000 ~

04

Qingdao China Tube Plant established

10

MF Battery Plant Started in Ulsan, Korea

17

Corporation Division
(DongAh Tire / DTR Automotive)

23

Quang Ngai Vietnam Tube Plant established

24

Corporation Merger (DN Automotive and DongAh Tire)



Vietnam Tube Plant

Production Items : Inner Tubes
Lot Area : 19,843 sq. ft
Location : Quang Ngai(Vietnam)



INNER TUBES

FLAPS

CURING ENVELOPES

CURING BLADDERS

PASSENGER CAR TUBES (RADIAL)

GROUP SIZE	TIRE SIZE APPLICATION	VALVE	Q'TY/CTN
ER10	145R10	TR13	40
DR12	125R12	TR13	40
ER12	135R/145R12, P135/75R12, P145/75R12 145/70R12, 155/70R12 140R150R12, 135/80R12, P145/80R12	TR13	40
FR12	155R12, P155/75R12, P165/75R12, P155/80R12 P165/80R12, 175/70R12, ZR70-12, BR12	TR13	33
ER13	135R/145R13, P135/75R13, P145/75R13 145/70R13, 155/70R13, 165/70R13 140/150R13, P135/80R13, P145/80R13	TR13	38
FR13	155R/165R13, P155/75R13, P165/75R13 175/70R13 160R13, BR13, P155/80R13, P165/80R13 175R/185R13, P175/80R13, P185/80R13	TR13	30
GR13	185/70R13, 195/70R13, 205/70R13 170R/180R13, P185/75R13, P185/75R13 CR70-13, BR70-13	TR13	28
KR13	DR70-13, ER70-13	TR13	25
ER14	135R/145R14, P135/75R14, P145/75R14 145/70R14, 155/70R14, 165/70R14 140R/150R14, P135/80R14, P145/80R14	TR13	35
FR14	155R/165R14, P155/75R14, P165/75R14 175/70R14, 185/70R14 160R14, BR14, CR78-14, P155/80R14, P165/80R14 175R/185R14, P175/75R14, P185/75R14	TR13	30
GR14	195/70R14, P175/80R14, P185/80R14 170R/180R14, CR14	TR13	25
KR14	195R/205R14, P195/75R14, P205/75R14, P215/75R14 205/70R14, 215/70R14, 225/70R14, P195/80R14 P205/80R14, DR70-14, ER70-14, FR70-14	TR13	25
DR15	125R15	TR13	35
ER15	135R/145R15, P135/75R15, P145/75R15 145/70R15, 155/70R15, 165/70R15 140R/150R15, P135/80R15, P145/80R15	TR13	30
FR15(L)	155R/165R15, P155/80R15, P165/80R15 175/70R15, 185/70R15 160R15, BR15, BR70-15, P155/75R15, P165/75R15 175R/185R15, P175/75R15, P185/75R15	TR13	30
GR15(L)	195/70R15, 205/70R15 170R/180R15, P175/80R15, P185/80R15 195R/205R15, P205/75R15, P215/75R15	TR13	25
KR15(L)	205/70R15, 215/70R15, 225/70R15, P225/70R15 GR70-15, P195/80R15, P205/80R15 215/225R15, P215/80R15, P225/80R15	TR13	22
MR15(L)	235/70R15, P225/75R15 HR70-15	TR13	20
GR16	175R/185R16	TR15	25
KR16	195R/205R16	TR15	20
MR16	215R/225R16	TR15	18

INNER TUBES

FLAPS

CURING ENVELOPES

CURING BLADDERS

PASSENGER CAR TUBES (BIAS)

GROUP SIZE	TIRE SIZE APPLICATION	VALVE	Q'TY/CTN
E-10	4.80/5.00/5.20-10 5.95/145-10, 5.9-10	TR13	40
D-12	4.00/4.40-12 5.35/125-12, 5.3-12	TR13	40
E-12	4.80/5.00/5.20/5.50-12 5.65/135-12, 5.95/145-12 5.9-12	TR13	40
F-12	5.60/6.00-12, 6.2-12 5.20/5.50-13	TR13	33
E-13	5.65/135-13, 5.95/145-13 5.9-13	TR13	38
F-13	5.60/5.90-13 6.15/155-13, 6.45/165-13 A78-13, Y78-13 6.2-13, 6.9-13 6.00/6.40/6.50/6.70-13	TR13	30
G-13	6.95/175-13, 7.35/185-13 B78-13, C78-13 7.3-13	TR13	28
K-13	7.00/7.25/7.50-13	TR13	25
E-14	5.00/5.20/5.50-14 5.65/135-14, 5.95/145-14	TR13	35
F-14	5.60/5.90-14 6.15/155-14, 6.45/165-14 6.2-14, 6.9-14 6.00/6.40/6.50/6.70-14	TR13	30
G-14	6.95/175-14, 7.35/185-14 C78-14, D78-14, 7.3-14	TR13	25
K-14	7.00/7.50/8.00-14 7.75/195-14, 8.25/205-14 E78-14, F78-14	TR13	25
D-15	4.00/4.25/4.40-15	TR13	35
E-15	5.20/5.50-15 5.65/135-15, 5.95/145-15, 6.2-15 5.60/5.90-15	TR13	30
F-15(L)	6.35/155-15, 6.85/165-15 165X380, 6.9-15	TR13	30
G-15(L)	6.00/6.40/6.50/6.70 7.15/175-15, 7.35/185-15 17X380, 7.3-15	TR13	25
K-15(L)	7.00/7.10-15 7.75/195-15, 8.15/205-15, G78-15	TR13	22
M-15(L)	7.50/8.00/8.20/9.00-15, 7.60-15, 8.85/215-15, 9.15-15, 8.00-16.5	TR13	20
G-16	6.00/6.50-16	TR15	25
K-16	7.00-16	TR15	20
M-16	7.50/8.25-16	TR15	18

INNER TUBES

FLAPS

CURING ENVELOPES

CURING BLADDERS

WIDE BASE TUBES (RADIAL)

WIDE BASE TUBES (BIAS)

LOW SECTION HEIGHT TUBES

SIZE	VALVE	Q'TY/CTN	SIZE	VALVE	Q'TY/CTN	SIZE	VALVE	Q'TY/CTN
7/8R14.5	TR300	23	7/8-14.5	TR300	23	16X6-8	TR13	30
8R16.5	TR15	25	8-16.5	TR15	25	16X6.50/7.50-8	TR13	30
8.75R16.5	TR15	18	8.75-16.5	TR15	18	18X7-8	TR244	30
9.5R16.5	TR15	15	9.5-16.5	TR15	15	18X8.50/9.50-8	TR13,TR244	20
10R16.5	TR15	12	10-16.5	TR15	14	21X12-8	TR4,TR13	20
11R16.5	TR15	10	11-16.5	TR15	10	22X11-8	TR4,TR13	20
12R16.5	TR15	7	12-16.5	TR15	8	21X8-9	TR13,TR244,TR75A	20
12.5R16.5	TR15	8	12.5-16.5	TR15	8	21X8.50/9.50-9	TR13	20
14R16.5	TR15	8	14-16.5	TR15	8	25X12/13.5-9	TR4	22
7R17.5	TR300	12	7-17.5	TR300	12	20.5X8.00-10	TR13	25
8R17.5	TR300	12	8-17.5	TR300	12	23X9-10	TR13,TR244	16
8.5R17.5	TR300	12	8.5-17.5	TR300	12	22X7.25-11.5	TR15	20
8R19.5	TR300	12	8-19.5	TR300	12	23X8.50-12	TR13	20
9R19.5	TR300	12	9-19.5	TR300	12	23X10.50-12	TR15	20
18R19.5	TR300	5	18-19.5	TR300	5	26X12.00-12	TR15	15
8R22.5	TR300	12	8-22.5	TR300	13	27X10-12	TR244,TR15	15
9R22.5	TR300	10	9-22.5	TR300	10	27X9.50/10.50-12	TR15	15
10R22.5	TR300	6	10-22.5	TR300	7	27X8.50-15	TR15	20
11R22.5	TR300	6	11-22.5	TR300	6	28X9-15	TR15	16
12R22.5	TR300	5	12-22.5	TR300	5	14.50-15	TR15	8
13R22.5	TR300	4	13-22.5	TR300	5	32X12-15	TR75A,TR78A	8
16R22.5	TR300	3	16-22.5	TR300	4	32X12.5-15	TR15	8
11R24.5	TR300	4	11-24.5	TR300	4	29X6.25-16	TR15	23
12R24.5	TR300	4	12-24.5	TR300	4			
15R19.5	TR300	5	15-19.5	TR300	5			
15R22.5	TR300	3	15-22.5	TR300	4			
18R22.5	TR300	3	18-22.5	TR300	4			

INNER TUBES

FLAPS

CURING ENVELOPES

CURING BLADDERS

LIGHT TRUCK TUBES (RADIAL)

TRUCK & BUS TUBES (RADIAL)

SIZE	VALVE	Q'TY/CTN	SIZE	VALVE	Q'TY/CTN	SIZE	VALVE	Q'TY/CTN
200R15	TR75A	16	250R15	TR75A	16	6.50R20	TR177A	14
300R15	TR75A	10	6.00R15	TR15	25	7.00R20	TR177A	12
6.00R15	TR75A	18	7.00R15	TR75A	16	7.50R20	TR177A	12
7.00R15	TR150	20	31X11.50-16.30X8.8	TR150	14	8.25R20	TR77A	10
7.50R15	TR75A	16	7.50R15	TR150	18	9.00R20	TR175A	9
8.15R15	TR177A	16	8.25R15	TR13, TR15	15	10.00R20	TR78A	7
34X11/36X11	TR13, TR15	15	8.25R15	TR75A, TR77A	14	11.00R20	TR78A	6
8.50R15	TR75A, TR77A	14	9.00R15	TR15, TR150	14	46X16	TR78A	5
9R15	TR15	20	9.00R15	TR175A	8	12.00R20	TR78A	5
10.00R15	TR78A	10	11.00R15	TR78A	8	13.00R20	TR78A	4
10/11R15	TR15	14	11/12R15	TR15	14	14.00R20	TR78A	3
4.00/450R16	TR13, TR15	30	5.00/550R16	TR15	28	49X17R20	TR78A	3
205R16	TR15	20	245R16	TR15	18	50X20.0R20	TR78A	3
6.00R16	TR75A	18	6.00R16	TR15	25	50X21.0R20	TR78A	3
6.50R16	TR15, TR150	25	6.50R16	TR75A	18	10.00R22	TR78A	6
7.00R16	TR15, TR150	20	7.00R16	TR75A	16	11.00R22	TR78A	5
7.50R16	TR15, TR150	18	32X8.8/30X8.0-16	TR15, TR150	16	12.00R22	TR78A	4
7.50R16	TR75A, TR177A	14	8.25R16	TR75A, TR177A	12	11.00R24	TR78A	4
9.00R16	TR15	14	9.00R16	TR177A	12	12.00R24	TR78A	4
280/85R16	TR15	10	10.00R16	TR15, TR78A	10	16.00R20	TR78A	3
11.00R16	TR15, TR78A	8	7.00R17	TR75A	14			
7.50R17	TR75A	14	8.25R17	TR75A	14			
7.00R18	TR75A	14	7.50R18	TR75A	14			
7.50R18	TR15	14	245/255/265R15	TR13	16			
22X7.25-11.5	TR150CW	35	31X10.5R15	TR13	14			
235/85R16	TR75A	12	275/70R16	TR13	14			

INNER TUBES



INNER TUBES

FLAPS

CURING ENVELOPES

CURING BLADDERS

LIGHT TRUCK TUBES (BIAS)

TRUCK & BUS TUBES (BIAS)

SIZE	VALVE	Q'TY/CTN	SIZE	VALVE	Q'TY/CTN	SIZE	VALVE	Q'TY/CTN
200-15	TR75A	18	250-15	TR75A	14	6.50-20	TR177A	15
300-15	TR75A	10	6.00-15	TR15	25	7.00-20	TR177A	12
6.00-15	TR75A	18	7.00-15	TR15	22	7.50-20	TR177A	12
280/60-14.5	TR13	28	7.00-15	TR75A	18	8.25-20	TR77A	10
30X11.50-14.5	TR150	14	7.50-15	TR177A	16	9.00-20	TR175A	9
7.50-15	TR150	18	8.15-15	TR75A, TR77A	16	10.00-20	TR78A	7
8.25-15	TR13, TR15	15	8.50-15	TR75A, TR77A	14	11.00-20	TR78A	6
8.25-15	TR75A, TR77A	14	9.00-15	TR175A	8	12.00-20	TR78A	5
9.00-15	TR15, TR150	14	11.00-15	TR78A	8	13.00-20	TR78A	5
10.00-15	TR78A	8	2011-12-15	TR15	14	14.00-20	TR78A	4
2010-11-15	TR15	14	5.00/5.50-16	TR15	28	44-16	TR78A	5
4.00/4.50-16	TR13, TR15	30	245-16	TR15	18	46-16	TR78A	5
205-16	TR15	20	6.00-16	TR15	25	49X17-20	TR78A	4
6.00-16	TR75A	18	6.50-16	TR75A	18	10.00-22	TR78A	6
6.50-16	TR15, TR150	25	7.00-16	TR75A	16	11.00-22	TR78A	5
7.00-16	TR15, TR150	20	7.50-16	TR75A, TR177A	15	12.00-22	TR78A	5
7.50-16	TR15, TR150	18	9.00/10.00-16	TR15	12	11.00-24	TR78A	5
8.25-16	TR75A, TR177A	12	280/85-16	TR15	10	12.00-24	TR78A	5
9.00-16	TR177A	12	10.00-16	TR78A	8	16.00-20	TR78A	3
10.00-16	TR15, TR218A	10	11.00-16	TR15	8	49X19	TR78A	4
11.00-16	TR78A	8	7.50-17	TR75A	14	47X18.0-18	TR78A	5
7.00-17	TR75A	14	7.00-18	TR75A	12	56X20.0-20	TR78A	4
8.25-17	TR75A	14	7.50-18	TR15	14	52X20.5-23	TR78A	4
7.50-18	TR75A	12	245/255/265-15	TR13	16			
8.00-18	TR15	14	31X10.5-15	TR13	14			
265/70-15	TR13	14	275/70-16	TR13	14			
235/85-16	TR75A	12						

INNER TUBES

FLAPS

CURING ENVELOPES

CURING BLADDERS

OFF THE ROAD TUBES (TG & NHS)

SIZE	VALVE	Q'TY/ CTN
9.00 - 20	TR175A	9
10.00 - 20	TR78A	7
11.00 - 20	TR78A	6
12.00 - 20	TR78A, TR220	5
11.00/11.00 - 24	TR78A, TR220	5
12.00 - 24	TR78A, TR220	5
13.00 - 24	TR78A, TR220	4
14.00 - 20	TR78A, TR220	4
14.00 - 24/25	TR78A, TRJ1175C	4
16.00 - 21	TR78A, TRJ1175C	3
16.00 - 24/25	TRJ1175C, TRJ4000	3
18.00 - 24/25	TRJ1175C, TRJ4000	2
18.00 - 33	TRJ1175C, TRJ4000	1
21.00 - 25	TRJ1175C, TRJ4000	2
24.00 - 25	TRJ1175C, TRJ4000	2
KM24	TRJ1175C, TRJ4000	4

* TG : TRACTOR, GRADER

* NHS : NOT FOR HIGHWAY SERVICE

OFF THE ROAD TUBES (TG & NHS)

SIZE	VALVE	Q'TY/ CTN
13.00-24	TR179A	4
14.00-24	TR179A	4
52X20.5-23	TR179A	3
16.00-24	TRJ1175C	3
56X20.0-20	TR78A	3
18.00-24	TRJ1175C	2
14.00-25	TRJ1175C	4
15.5-25	TRJ1175C	4
16.00-25	TRJ1175C	3
20.5-25	TRJ1175C	2
64X22.5-26	TRJ1175C	2
23.5-25	TRJ1175C	2
26.5-25	TRJ1175C	2
18.00-33	TRJ1175C	1
26.5-29	TRJ1175C	1
29.5-25	TRJ1175C	1
29.5-29	TRJ1175C	1

TWIN TUBES FOR FARM & IMPLEMENTS

SIZE	VALVE	Q'TY/ CTN
500/55-15.5	TR15 (TR218A)	4
19.0/45R17/ 500/50R17	TR15 (TR218A)	4
400/55R22.5/ 400/60R22.5	TR218A	4
500/45R22.5	TR218A	3
500/60R22.5	TR218A	2
600/50R22.5	TR218A	2
700/40-22.5	TR218A	2
400/60-26.5	TR218A	3
500/60R26.5	TR218A	2
600/55R26.5	TR218A	2
700/50R26.5	TR218A	2
800/40R26.5	TR218A	2
600/55R30.5/ 600/60R30.5	TR218A	2
700/50R30.5/ 800/45R30.5	TR218A	1
600/65-34	TR218A	2
700/55-34	TR218A	1
500/60-38	TR218A	2
600/55-38	TR218A	2
650/60-38	TR218A	1
700/65R38/ 750/65R38/ 710/70R38	TR218A	1



INNER TUBES

INNER TUBES

FLAPS

CURING ENVELOPES

CURING BLADDERS

FARM TUBES

SIZE	VALVE	Q'TY/ CTN	SIZE	VALVE	Q'TY/ CTN
8.3/8R22 (260/70R22)	TR218A, TR220A	12	32 X 88	TR218A, TR220A	16
8.3R24/8R24 (260/70R24)	TR218A, TR220A	12	16.9R34/14R34 (480/70R34)	TR218A, TR220A	3
9.5R24/9R24 (300/70R24)	TR218A, TR220A	12	18.4R34/15R34 (520/70R34)	TR218A, TR220A	2
11.2R24/10R24 (320/70R24)	TR218A, TR220A	9	20.8R34 (580/70R34)	TR218A, TR220A	2
12.4R24/11R24 (360/70R24)	TR218A, TR220A	6	23.1R34 (620/75R34)	TR218A, TR220A	1
12.4/11-26	TR218A, TR220A	6	4.00/4.50/5.00R36	TR218A, TR220A	7
13.6R24/12R24 (380/70R24)	TR218A, TR220A	6	9.5R36/9R36 (230/95R36)	TR218A, TR220A	6
14.9R24/13R24 (420/70R24)	TR218A, TR220A	5	11.2R36/10R36 (320/70R36)	TR218A, TR220A	5
KM24	TR218A, TR220A	4	12.4R36/11R36 (360/70R36)	TR218A, TR220A	5
15.5/80R24	TR218A, TR220A	5	13.6R36/12R36 (380/70R36)	TR218A, TR220A	4
16.5/80R24	TR218A, TR220A	4	11.2R38/10R38 (320/70R38)	TR218A, TR220A	5
16.9R24/14R24 (480/70R24)	TR218A, TR220A	4	12.4R38/11R38 (360/70R38)	TR218A, TR220A	4
18.4R24/15R24	TR218A, TR220A	4	13.6R38/12R38 (380/70R38)	TR218A, TR220A	4
14.9R26/13R26 (420/70R26)	TR218A, TR220A	5	14.9R38/13R38 (420/70R38)	TR218A, TR220A	4
16.9R26/14R26 (480/70R26)	TR218A, TR220A	3	15.5R38 (420/70R38)	TR218A, TR220A	4
18.4R26/15R26 (520/70R26)	TR218A, TR220A	3	16.9R38/14R38 (480/70R38)	TR218A, TR220A	3
23.1R26 (620/75R26)	TR218A, TR220A	2	18.4R38/15R38 (520/70R38)	TR218A, TR220A	2
28LR26 (750/65R26)	TR218A, TR220A	1	20.8R38 (580/70R38)	TR218A, TR220A	2
9.5R28/9R28 (300/70R28)	TR218A, TR220A	7	9.5R42/9R42 (230/95R42)	TR218A, TR220A	5
11.2R28/10R28 (320/70R28)	TR218A, TR220A	7	13.6R/12R42	TR218A, TR220A	3
12.4R28/11R28 (360/70R28)	TR218A, TR220A	5	18.4R/15R42 (520/70R42)	TR218A, TR220A	2
13.6R28/12R28 (380/70R28)	TR218A, TR220A	5	20.8R42 (580/70R42)	TR218A, TR220A	2
14.9R28/13R28 (420/70R28)	TR218A, TR220A	5	9.5R44/9R44 (230/95R44)	TR218A, TR220A	5
16.9R28/14R28 (480/70R28)	TR218A, TR220A	3	12.4R46/11R46 (360/70R46)	TR218A, TR220A	3
16.5/80R28	TR218A, TR220A	3	18.4R46/15R46	TR218A, TR220A	1
18.4R28/15R28 (520/70R28)	TR218A, TR220A	3	9.5R48/9R48 (230/90R48)	TR218A, TR220A	7
21L28	TR218A, TR220A	1	11.2R48/10R48 (270/95R48)	TR218A, TR220A	5
14.9R30/13R30 (420/70R30)	TR218A, TR220A	4	16.9R50/14R50	TR218A, TR220A	1
16.9R30/14R30 (480/70R30)	TR218A, TR220A	3	10.5/80R20 (275/80R20)	TR218A, TR220A, TR15	10
18.4R30/15R30 (520/70R30)	TR218A, TR220A	2	12.5/80R20 (335/80R20)	TR218A, TR220A, TR15	7
23.1R30 (620/75R30)	TR218A, TR220A	2	14.5/80R20 (375/80R20)	TR218A, TR220A, TR15	6
8.3R32/8R32 (260/70R32)	TR218A, TR220A	8	15.5R20	TR218A, TR220A, TR15	5
9.5R32/9R32 (300/70R32)	TR218A, TR220A	8	16.0/70R20 (405/70R20)	TR218A, TR220A, TR15	5
12.4R32/11R32 (360/70R32)	TR218A, TR220A	5	20.0/70R20 -508	TR150, V3	3
24.5R32 (650/75R32)	TR218A, TR220A	1	16.5/18R22.5	TR218A, TR220A, TR15	4
30.5R32 (800/65R32)	TR218A, TR220A	1	360/70R20	TR218A	5
30 X 88	TR218A, TR220A	16	320/85R20	TR218A	7

INNER TUBES

FLAPS

CURING ENVELOPES

CURING BLADDERS

INDUSTRIAL, IMPLEMENT TUBES

SIZE	VALVE	Q'TY/CTN
4.00-8	TR87, TR89, TR244	40
4.00-8	TR13	45
5.00-8	TR244	35
5.00-8	TR13	40
6.00-9	TR75A	25
6.00-9	TR13, TR244	30
4.00/4.50-10	TR13	40
5.00-10	TR244, TR75A	35
5.00-10	TR13	40
6.50-10	JS2, TR75A	25
7.50-10	TR244, TR75A	20
9.00-10	TR75A	18
5.00-12	TR13	40
6.00-12	TR13	33
7.00-12	TR75A	20
7.00-12	TR13	23
10.0/80-12	TR15	15
8.50-12	TR15	20
23X10-12	TR150CW	18
9.00-13	TR15	16
7.5/9.5L14/15	TR15	16
07-14	TR13	25
9.5L-14/15	TR15	16
5.00-15	TR15	30
8.15-15	TR177A	16
200/60-14.5	TR15	25
12.5L-15/16	TR15	12
2010-11-15	TR15	14
10.0/75-15.3	TR15	14
12.5/60-15	TR15	15
11.5/80-15.3	TR15	12
12.5/80-15.3	TR15	12
280/60-15.5	TR15	14
350/70-15.5	TR15	6
350/70-17.5	TR15	6
400/60-15.5	TR15	8

SMALL INDUSTRIAL & SCOOTER TUBES

SIZE	VALVE	Q'TY/CTN
2.80/2.50-4	TR87	100
4.10/3.50-4	TR13	90
4.10/3.50-4	TR87	90
4.10/3.50-5	TR13	80
4.10/3.50-5	TR87	80
11X4.00/4.50/6.00-5	TR87	70
13X5.00/6.50-6	TR13	55
15X6.00-6	TR13	50
4.10/3.50-6	TR13	70
4.10/3.50-6	TR87	70
5.30/4.50-6	TR87	55
3.50/3.00-8	TR13	55
3.50/3.00-8	TR87	55
8.00R6/7	TR87	30





FIT TIRE SIZE	FLAP SIZE (INCH)	WIDTH (MM)	PACKING FLAPS / CARTON	CONTAINER LOAD(20`) CARTONS	CARTON CBM
5.00-8	8-4.6	118	12	960	0.2088
6.00-9	9-4.6	118	12	960	0.2088
6.50/7.50-10	10-5.8	147	12	960	0.2088
7.00-12	12-5.7	144	12	960	0.2088
23X10-12	12-8.5	215	12	960	0.2088
6.50/7.00/7.50/8.25-15	15-7.4	187	12	960	0.2088
8.25/9.00-15	15-7.1	180	10	690	0.04
9.00/10.00/11.00-15	15-8.3	210	10	690	0.04
7.00/7.50R16(DC)	16-6.8	173	10	960	0.0288
7.00/7.50R16(SDC)	16-6.8	173	10	960	0.0288
6.50/7.00/7.50/8.25-16	16-6.9	176	10	960	0.0288
8.25/9.00-16	16-7.1	180	10	960	0.0288
7.00/7.50-18	18-6.8	173	10	690	0.04
6.50/7.00/7.50/8.25-20	20-7.8	198	10	630	0.044
8.25/9.00-20	20-8.0	202	10	630	0.044
9.00R20(20R7.0)	20-7.0	178	10	630	0.044
9.00-20(20R6.0)	20-6.0	154	10	630	0.044
10.00/11.00/12.00-20	20-8.2	208	10	630	0.044
10.00/11.00/12.00R20	20-8.2	208	10	630	0.044
12.00-20	20-8.2	208	10	630	0.044
12.00R20	20-8.2	208	10	630	0.044
10.00/11.00/12.00-22	22-8.3	210	8	630	0.044
10.00/11.00/12.00R22	22-8.3	210	8	630	0.044
10.00/11.00/12.00-24	24-9.1	230	6	690	0.04
10.00/11.00/12.00R24	24-9.1	230	6	690	0.04
13.00/14.00/16.00-20	20-9.8	250	8	460	0.06
13.00/14.00-24/25	24-11.1	282	5	590	0.0469
16.00-20/21	20-11.8	300	5	580	0.0479
16.00-24/25	24-11.1	282	5	590	0.0469
15.5/17.5-25	25-13.2	336	5	435	0.0633
18.00-25	25-13.2	336	5	435	0.0633
20.5-25	25-17.7	450	3	610	0.0455
23.5-25	25-19.5	495	3	520	0.0532
26.5-25	25-23.2	590	2	370	0.0739

CURING ENVELOPES(SHORT SKIRT)

ORDER NO.	SKIRT LENGTH	FIT TIRE SIZE		Q'TY/CTN
		STANDARD	METRIC	
1 SE	370MM	"12.00-20, 11.00-22, 15-22.5"		5
2 SE	311	11.00-20, 10.00-22, 11-24.5		5
3 SE	302	10.00-20, 11/12-22.5	"295/80R22.5, 285/75R24.5, 275/80R24.5"	5
4 SE	275	9.00-20, 10.00-22.5	"275/80R22.5, 295/75R22.5, 315/70R22.5"	6
5 SE	260	7.50-20, 8.25-20, 9-22.5	"245/75R22.5, 255/70R22.5, 265/75R22.5, 275/65R22.5, 295/70R22.5"	6
6 SE	302	10.00-15		6
7 SE	260	"7.00-17/18, 7.50-18, 8-19.5, 9.00-15, 9.00-16/16.5"		7
8 SE	230	"7.00/7.50-15/16, 6.00/6.50-16"		8

CURING ENVELOPES(LONG SKIRT)

ORDER NO.	SKIRT LENGTH	FIT TIRE SIZE		Q'TY/CTN
		STANDARD	METRIC	
1 LE	356MM	11.00-24, 11-24.5		4
2 LE	381	"10.00-22, 11.00-22, 12-22.5, 13-22.5"		4
3 LE	457	16.5-22.5		3
	406	"11.00-20, 12.00-20, 14/80R20, 15-22.5"		4
5 LE	330	11-22.5		4
6 LE	356	10.00-20	"295/80R22.5, 275/80R24.5, 285/75R24.5"	4
7 LE	381	13/80R20	"315/75R22.5, 315/80R22.5"	5
8 LE	330	9.00-20, 10-22.5		5
9 LE	305	7.50-20, 8.25-20, 9-22.5	"295/75R22.5, 315/70R22.5"	5
10 LE	381	10.00-15, 11.00-15	"245/75R22.5, 265/75R22.5, 295/70R22.5"	5
11 LE	267	"7.50-17, 10-17.5, 7.00-18, 7.50-18, 8-19.5, 6.50-20, 7.00-20"		5
12 LE	292	8.25-16, 9-19.5		5
13 LE	318	9.00-15, 9.00-16, 8.25-17		6
14 LE	229	8-16.5, 8.5-17.5	215/85R16	7
15 LE	254	"8.75-16.5, 9.50-16.5, 7.00-17"	"P235/75R15, 235/85R16"	8
16 LE	279	"7.00-15, 7.50-15, 7.60-15, 8.25-15, 7.00-16, 7.50-16"		8

CURING ENVELOPES(EXTENDED SKIRT)

ORDER NO.	SKIRT LENGTH	FIT TIRE SIZE		Q'TY/CTN
		STANDARD	METRIC	
1 ES	381MM	11-24.5	315/80R22.5	4
2 ES	406	"10.00-22, 11.00-22, 12-22.5, 13-22.5"		4
3 ES	432	"11.00-20, 12.00-20, 14/80R20, 15-22.5"		4
4 ES	457	16.5-22.5		3
5 ES	356	11-22.5	295/80R22.5	5
6 ES	381	10.00-20	"315/75R22.5, 315/80R22.5"	5
7 ES	406	13/80R20		5
8 ES	330	10-22.5	275/80R22.5	5
9 ES	357	9.00-20	"295/75R22.5, 315/70R22.5"	5
10 ES	305	9-22.5	265/75R22.5	5
11 ES	330	8.25-20	"245/75R22.5, 295/70R22.5"	5
12 ES	267	7.00-18, 8-19.5, 6.50-20		5
13 ES	292	"7.50-17, 10-17.5, 7.50-18, 7.00-20"		5
14 ES	318	8.25-16, 9-19.50		6
15 ES	343	9.00-16, 8.25-17, 9.00-15		5
16 ES	254	8-16.5, 8.75-16.5, 8.5-17.5	"P235/75R15, 215/85R16"	8
17 ES	279	"7.00-15, 7.00-16, 7.50-15, 7.50-16, 7.60-15, 9.50-16.5, 7.00-17"	235/85R16	8
18 ES	330	"275/80R24.5, 285/75R24.5"		5

RIMLESS CURING ENVELOPES

ORDER NO.	SKIRT LENGTH	FIT TIRE SIZE		Q'TY/CTN
		STANDARD	METRIC	
RC 1	432MM	11R24.5		4
RC 4	420	11R22.5	"275/80R24.5, 285/75R24.5"	4
RC 5	455	"10.00R20, 11.00R20, 13/80R20"	"295/80R22.5, 315/75R22.5"	4
RC 10	381	825R20	265/75R22.5	5
RC 15	279	8R16.5		8

RIMLESS CURING ENVELOPES

SIZE	VALVE	PCS/CTN	SIZE	VALVE	PCS/CTN	SIZE	VALVE	PCS/CTN
7.50-16	Z1-01-03 9	9	7.50-16	Z1-01-03 9	9	7.50-16	Z1-01-03 9	9
7.50-17	Z1-01-03 8	8	7.50-17	Z1-01-03 8	8	7.50-17	Z1-01-03 8	8
8.25-16	Z1-01-03 8	8	8.25-16	Z1-01-03 8	8	8.25-16	Z1-01-03 8	8
8.25-20	Z1-01-03 7	7	8.25-20	Z1-01-03 7	7	8.25-20	Z1-01-03 7	7
9.00-20	Z1-01-03 5	5	9.00-20	Z1-01-03 5	5	9.00-20	Z1-01-03 5	5
10.00-15	Z1-01-03 6	6	10.00-15	Z1-01-03 6	6	10.00-15	Z1-01-03 6	6
10.00-20	Z1-01-03 5	5	10.00-20	Z1-01-03 5	5	10.00-20	Z1-01-03 5	5

CURING BLADDER

NO.	Group	Reference Size	A	B	C	D	E	F	G	H	Weight (kg)
			Crown Guage (mm)	Foot ID (mm)	Foot Height (mm)	Foot Width (mm)	Neck Guage (mm)	Outside Diameter (mm)	Over-all Height (mm)	Periphery (mm)	
1	PCR	13"~14"	4.0~5.0	228	24	12	8	350~508	298~363	360~500	2.46~3.72
		15"~17"	4.0~5.0	276~300	23.0~25.0	12.5~14.2	8	423~560	210~420	334~566	3.04~5.66
2	UHPT	17"~18"	4.0~5.0	300	25	14.2	8	305~390	305~390	420~594	4.01~6.20
		19"~20"	4.5~5.0	350	25	14.2	8	545~674	343~398	468~590	4.84~7.46
		21"~22"	5	410	24	12	7	574~680	280~400	454~558	5.19~6.94
3	LTR	15"~16"	7	276	23	12.5	8	398~570	325~484	424~604	4.46~7.87
		17"~18"	7	300~350	25	14.2	8~10	550~620	410~573	541~715	7.66~11.5
4	TBR	19.5"~22.5"	6.5~10.0	356~384	27	13	14~15	606~810	395~642	537~895	9.0~19.5
		22.5"~24"	7.5~10.0	436~488	27	13	14~15	736~904	490~660	703~804	15.6~20.13

AIR SPRING BLADDER

NO.	Bladder Code	A	B	C	D	E	F	G	H	Weight (kg)		
		Crown Guage (mm)	Foot ID (mm)	Foot Height (mm)	Foot Width (mm)	Neck Guage (mm)	Outside Diameter (mm)	Over-all Height (mm)	Periphery (mm)			
1	177A1	5.1	74	16.9	6	6	133.7	310.9	330.54	0.77		
2	177A2	5.1	74	16.9	6	6	133.7	412.9	432.84	1		
3	177A3	5.1	74	16.9	6	6	133.7	458	477.64	1.14		
4	177F4	6.5	90	16.5	6	6.5	150	498.3	515.7	1.65		
5	177F5	6.5	90	16.5	6	6.5	150	549.3	566.7	1.82		
6	177D2	5.25	91	125	16.5	7.5	5.25	183	506.25	533.56	1.66	
7	177S1	6.2	257	23	18.7	12.75	7	6.7	618	229.8	515.53	5.72

ENVELOPE(INJECTION TYPE)

NO.	Envelope Code	A	B	C	D	E	F	G	H	Weight (kg)
		Crown Guage (mm)	Foot ID (mm)	Foot Height (mm)	Foot Width (mm)	Neck Guage (mm)	Outside Diameter (mm)	Over-all Height (mm)	Periphery (mm)	
1	16LE, 17ES	2.90	386	4.0	6.0	2.7	795.8	227.6	563	3.31



TUBE VALVES

MODEL	A(mm)	B(mm)	C(mm)	L(mm)
TR13	56	3.0	11.5	38
TR15	56	3.0	16.5	38
TR150	56	3.0/4.5	15.6	93.5

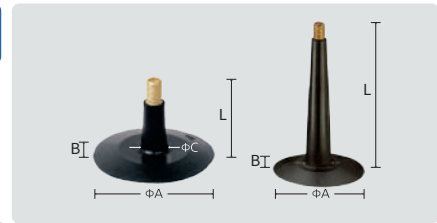

MODEL	A(mm)	B(mm)	C(mm)	L(mm)	α°
TR244	56	4.5	3.3	30.5	90
JS2	56	4.5	3.3	30.5	70
TR87	87	4.0	3.3	19	90

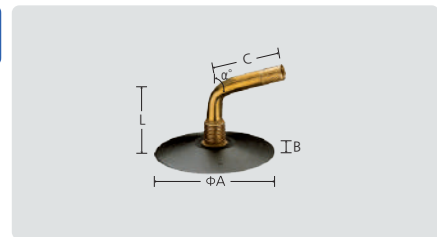

MODEL	A(mm)	B(mm)	C(mm)	L(mm)	α°
TR75A	95	6.7	76	24	86
TR77A	124	6.7	105	24	86
TR78A	146	6.7	127	24	86
TR175A	134	6.7	115	24	86
TR177A	114	6.7	95	24	86
TR179A	160	6.7	141	24	86

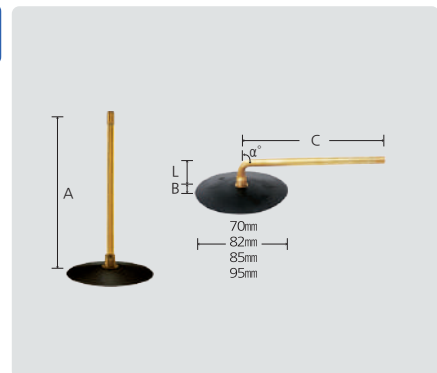

MODEL	C(mm)	L(mm)	α°
V3-02-7	71.5	22.5	100
V3-02-8	89.5	20.5	94
V3-02-10	115	20.5	94

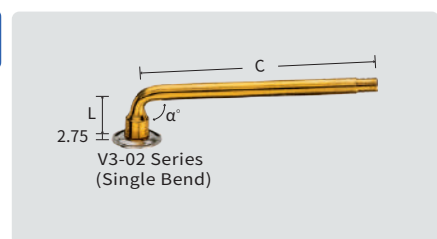

MODEL	C(mm)	D(mm)	L(mm)	α°	β°
V3-04-2	38	41.5	20.5	90	153
V3-04-5	76	47.5	20	90	153

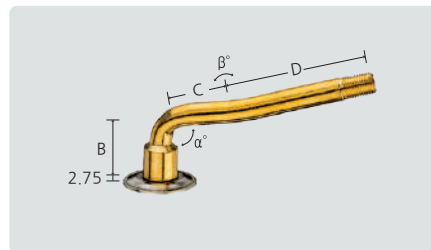

MODEL	B(mm)	C(mm)	D(mm)	L(mm)	α°	β°	γ°
V3-06-5	62.5	19.5	49	20.5	90	139	139
V3-06-8	61.5	14.5	50.5	24.5	94	153	153
V3-06-16	62	62	50	20	94	153	153

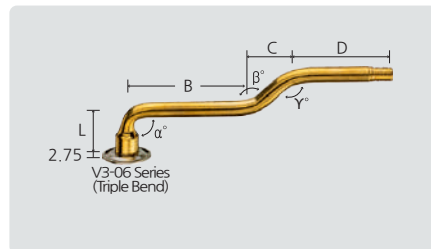

MODEL	A(mm)	B(mm)	L(mm)
TR218A	63.5/82	5.2/6.4	20.5
TR220A	63.5/82	5.2/6.4	30

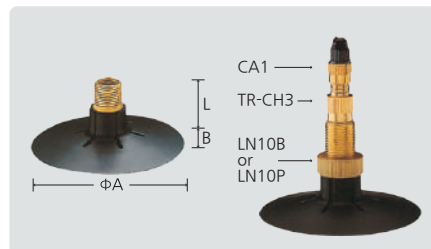

MODEL	A(mm)	B(mm)	C(mm)	L(mm)	α°
TRJ1175C	32	4.0	105	35	88

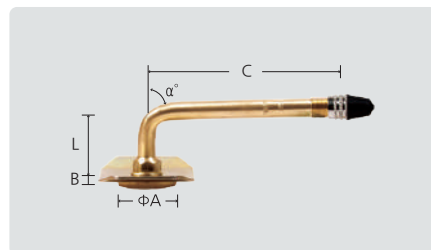

MODEL	A(mm)	B(mm)	L(mm)
TR300	70	7.0	57.5



MODEL	A(mm)	B(mm)	L(mm)
TR4	45	4.5	34



DONGAH QUALITY ASSURANCE FOR INNER TUBES (BRIEFS)

01. SCOPE

- Quality assurance of butyl rubber tubes manufactured by DN Automotive Corporation

02. PHYSICAL PROPERTIES

CATEGORY	BODY PART TENSILE	SPLICE(JOINT) PART TENSILE	ULTIMATE ELONGATION	PERMANENT SET AFTER AGING
MINIMUM	8.4 Mpa	3.5 Mpa	500%	MAX 30%

04. PRODUCTS GUARANTEE

- 1) Warranty of 2 years under the normal storage condition
- 2) The compensation will be paid if the defect is judged as manufacturer's fault after investigating the defected product or the picture of it which is in use or stocked under the warranty period.
- 3) Claim settlement : Basically compensate without the defects verification for the minor small quantity for smooth and speedy business progress. However, large volume claim or frequent small quantity ones should be identified by verifying the defected parts or personal visit investigation.

05. HANDLING PRECAUTIONS

- 1) Store the product in a box indoors without sun-light. (Crack prevention)
- 2) Be careful not to damage the contents by sharp tools
Only for sizes of tire marked on products & boxes are allowed to be used.
- 3) Before installation, make sure that there's no foreign matter in the rim and tire.

06. CLAIM REQUEST / REQUIREMENT

- 1) HOW TO CONTACT
 - ① PHONE : +82 55 370 7741 ~ 5
 - ② E-MAIL : kjelee@dncompany.com
 - ③ ADDRESS : 11, Yusangongdan 11-gil, Yangsan-si, Gyeongsangnam-do, Korea (50592)
- 2) HOW TO REQUEST
 - Please send the actual product or the picture by E-MAIL if the defect is suspected as manufacturer's negligence.
 - Please call us or e-mail if you have any requirements.

07. QUALITY (SYSTEM) CERTIFICATION

ISO 9001 / KS (KOREA STANDARD) / SNI (INDONESIAN NATIONAL STANDARD) / BIS (BUREAU INDIAN STANDARDS)

※ Please contact us if you need to mark the quality certification on the product or packaging.

STUFFING PROGRAM (AUTOMOBILE TUBES)

PACKING

Each piece of tube wrapped in a blank vinyl bag and sizable numbers of tubes packed in a carton

STUFFING

585 Cartons available for 20ft container by normal carton and 1000 cartons available for 40ft container by normal carton subject to legal weight limit

CARTON MEASUREMENT

NORMAL ONE : 0.0481 CBM / LARGE ONE : 0.0551 CBM

REF : Available max 28 CBM for 20ft container and 48 CBM for 40ft container due to legal weight limit.

Box size : 470*320*320(mm)





D STORY **N** OW & NEW

DN AUTOMOTIVE

DN Automotive Corporation

HOMEPAGE <http://www.dongahtire.co.kr>

ADDRESS 11, Yusangongdan 11-gil, Yangsan-si, Gyeongsangnam-do, Korea(50592)

TEL +82-55-370-7741~5

EMAIL kjelee@dncompany.com